

User Manual

Line Interactive Sinewave UPS 800/1.1K/1.5K/2K/2.5K/3K VA

Uninterruptible Power Supply System

Table of Contents

1. Important Safety Warning.....	1
1-1. Transportation.....	1
1-2. Preparation	1
1-3. Installation.....	1
1-4. Operation	1
1-5. Maintenance, Service And Faults	2
2. Installation And Setup	3
2-1. Rear Panel View	3
2-2. Install The UPS	4
2-3. Setup The UPS.....	4
2-4 Battery Replacement	6
2-5 Battery Kit Assembly (option).....	7
3. Operations	9
3-1. Button Operation.....	9
3-2. LCD Panel	9
3-3. Audible Alarm	10
3-4. LCD Display Wordings Index	11
3-5. UPS Setting.....	11
3-6. Operating Mode Description	14
3-7. Faults Reference Code	15
3-8. Warning Indicator.....	16
4. Troubleshooting	17
5. Storage and Maintenance	18
6. Specifications.....	19

1. Important Safety Warning

Please comply with all warnings and operating instructions in this manual strictly. Save this manual properly and read carefully the following instructions before installing the unit. Do not operate this unit before reading through all safety information and operating instructions carefully

1-1. Transportation

- Please transport the UPS system only in the original package to protect against shock and impact.

1-2. Preparation

- Condensation may occur if the UPS system is moved directly from cold to warm environment. The UPS system must be absolutely dry before being installed. Please allow at least two hours for the UPS system to acclimate the environment.
- Do not install the UPS system near water or in moist environments.
- Do not install the UPS system where it would be exposed to direct sunlight or near heater.
- Do not block ventilation holes in the UPS housing.

1-3. Installation

- Do not connect appliances or devices which would overload the UPS system (e.g. laser printers) to the UPS output sockets.
- Place cables in such a way that no one can step on or trip over them.
- Do not connect domestic appliances such as hair dryers to UPS output sockets.
- The UPS can be operated by any individuals with no previous experience.
- Connect the UPS system only to an earthed shockproof outlet which must be easily accessible and close to the UPS system.
- Please use only VDE-tested, CE-marked mains cable (e.g. the mains cable of your computer) to connect the UPS system to the building wiring outlet (shockproof outlet).
- Please use only VDE-tested, CE-marked power cables to connect the loads to the UPS system.
- When installing the equipment, it should ensure that the sum of the leakage current of the UPS and the connected devices does not exceed 3.5mA.

1-4. Operation

- Do not disconnect the mains cable on the UPS system or the building wiring outlet (shockproof socket outlet) during operations since this would cancel the protective earthing of the UPS system and of all connected loads.
- The UPS system features its own, internal current source (batteries). The UPS output sockets or output terminals block may be electrically live even if the UPS system is not connected to the building wiring outlet.
- In order to fully disconnect the UPS system, first press the OFF/Enter button to disconnect the mains.
- Prevent no fluids or other foreign objects from inside of the UPS system.

1-5. Maintenance, Service And Faults

- The UPS system operates with hazardous voltages. Repairs may be carried out only by qualified maintenance personnel.
- **Caution** - risk of electric shock. Even after the unit is disconnected from the mains (building wiring outlet), components inside the UPS system are still connected to the battery and electrically live and dangerous.
- Before carrying out any kind of service and/or maintenance, disconnect the batteries and verify that no current is present and no hazardous voltage exists in the terminals of high capability capacitor such as BUS-capacitors.
- Only persons are adequately familiar with batteries and with the required precautionary measures may replace batteries and supervise operations. Unauthorized persons must be kept well away from the batteries.
- **Caution** - risk of electric shock. The battery circuit is not isolated from the input voltage. Hazardous voltages may occur between the battery terminals and the ground. Before touching, please verify that no voltage is present!
- Batteries may cause electric shock and have a high short-circuit current. Please take the precautionary measures specified below and any other measures necessary when working with batteries:
 - remove wristwatches, rings and other metal objects
 - use only tools with insulated grips and handles.
- When changing batteries, install the same number and same type of batteries.
- Do not attempt to dispose of batteries by burning them. This could cause battery explosion.
- Do not open or destroy batteries. Escaping electrolyte can cause injury to the skin and eyes. It may be toxic.
- Please replace the fuse only with the same type and amperage in order to avoid fire hazards.
- Do not dismantle the UPS system.
- **WARNING:** This is a category C2 UPS product. In a residential environment, this product may cause radio interference, in which case the user may be required to take additional measures. (only for 220/230/240 VAC system)

Only for 110/120 VAC system:

- **NOTE:** This equipment has been tested and found to comply with the limits for a Class A digital device, pursuant to part 15 of the FCC Rules. These limits are designed to provide reasonable protection against harmful interference when the equipment is operated in a commercial environment. This equipment generates, uses, and can radiate radio frequency energy and, if not installed and used in accordance with the instruction manual, may cause harmful interference to radio communications. Operation of this equipment in a residential area is likely to cause harmful interference in which case the user will be required to correct the interference at his own expense.
- **WARNING:** Changes or modifications not expressly approved by the party responsible for compliance could void the user's authority to operate the equipment.

2. Installation And Setup

NOTE: Before installation, please inspect the unit. Be sure that nothing inside the package is damaged. Please keep the original package in a safe place for future use.

2-1. Rear Panel View

800/1.1K/1.5K IEC Type

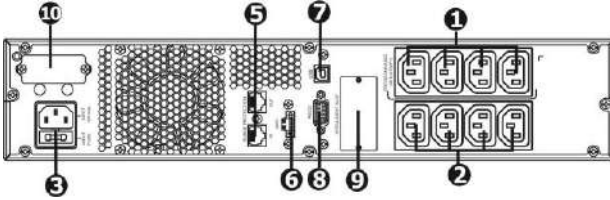

2K IEC Type

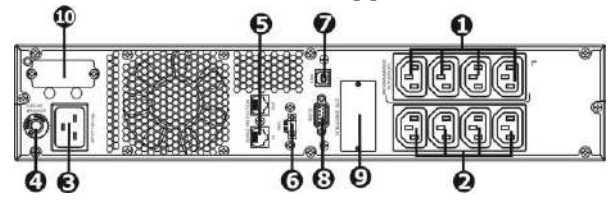

2.5K/3K IEC Type

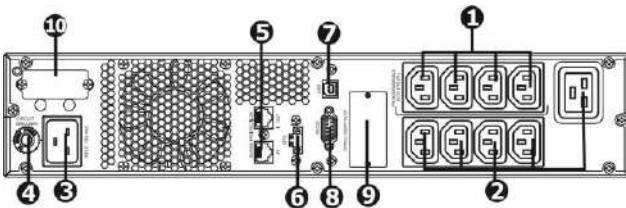

800/1.1K/1.5K NEMA Type

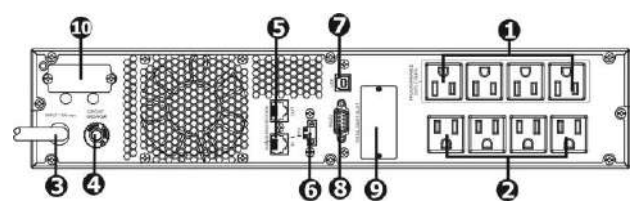

2K NEMA Type

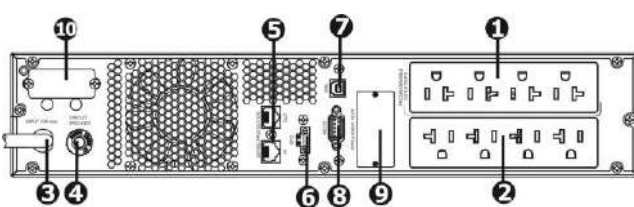

2.5K/3K NEMA Type

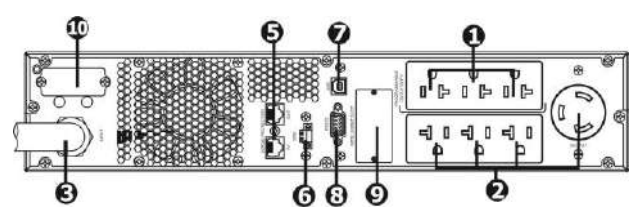

800/1.1K/1.5K Schuko Type

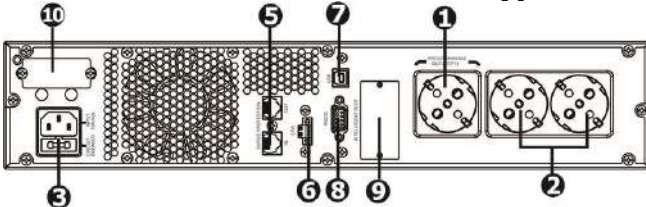

2K Schuko Type

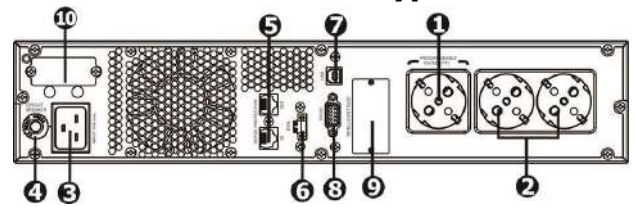

2.5K/3K Schuko Type

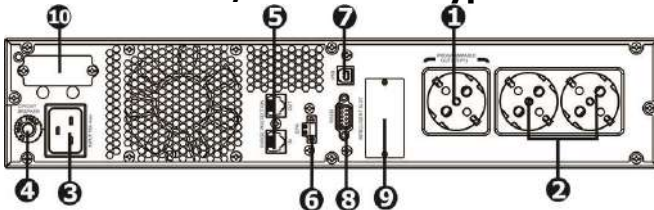

1. Programmable outlets: connect to non-critical loads.
2. Output receptacles: connect to mission-critical loads.
3. AC input
4. Input circuit breaker
5. Network/Fax/Modem surge protection
6. Emergency power off function connector (EPO)
7. USB communication port
8. RS-232 communication port
9. SNMP intelligent slot
10. External battery connector (only available for L model)

2-2. Install The UPS

For safety consideration, the UPS is shipped out from factory without connecting battery wires. Before install the UPS, please follow below steps to re-connect battery wires first.

Step 1

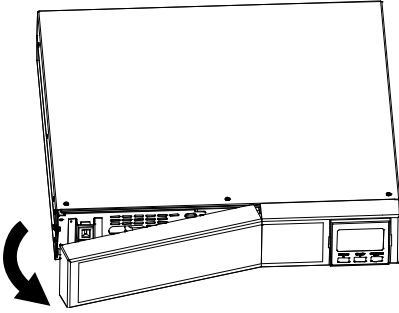

Remove front panel.

Step 2

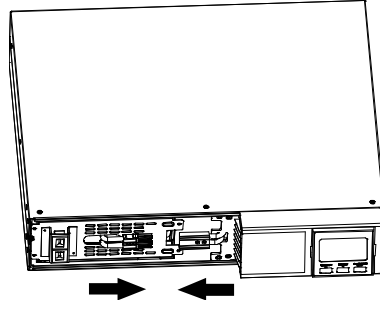

Connect the AC input and re-connect battery wires.

Step 3

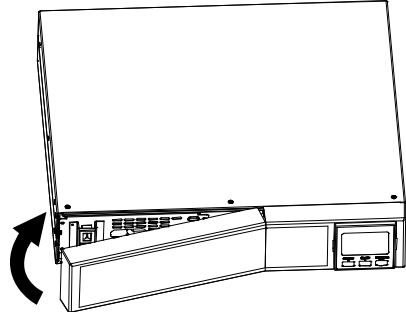

Put the front panel back to the unit.

Rack-mount Installation

Step 1

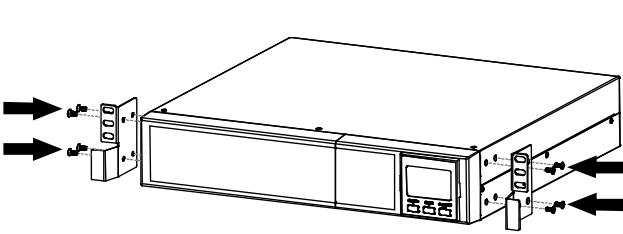

Step 2

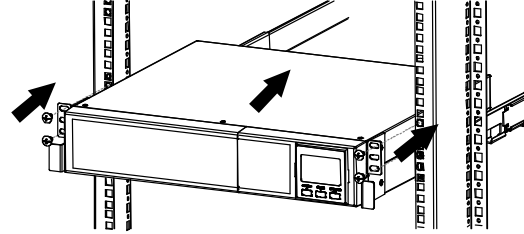

Tower Installation

Step 1

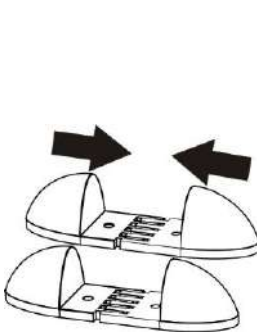

Step 2

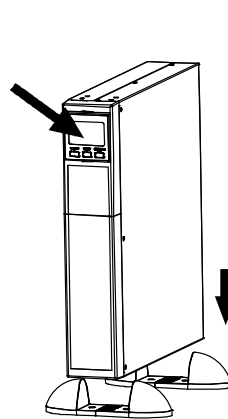
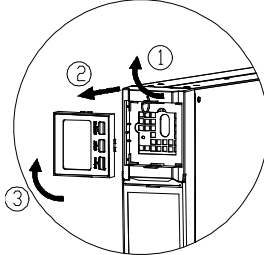

Step 3

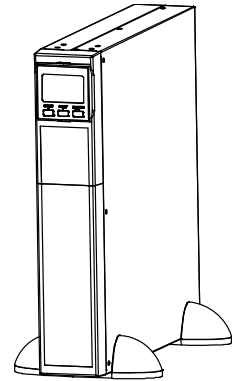

2-3. Setup The UPS

Step 1: UPS input connection

Plug the UPS into a two-pole, three-wire, grounded receptacle only. Avoid using extension cords.

Step 2: UPS output connection

There two kinds of outputs: programmable outlets and general outlets. Please connect non-critical devices to the programmable outlets and critical devices to the general outlets. During power failure, you may extend the backup time to critical devices by setting shorter backup time for non-critical devices.

Step 3: Communication connection

Communication ports:

USB port



RS-232 port

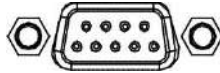

Intelligent slot



To allow for unattended UPS shutdown/start-up and status monitoring, connect the communication cable one end to the USB/RS-232 port and the other to the communication port of your PC. With the monitoring software installed, you can schedule UPS shutdown/start-up and monitor UPS status through PC.

The UPS is equipped with intelligent slot perfect for either SNMP or AS400 card. When installing either SNMP or AS400 card in the UPS, it will provide advanced communication and monitoring options.

PS. USB port and RS-232 port can't work at the same time.

Step 4: Network connection

Network/Fax/Phone surge port



Connect a single modem/phone/fax line into surge-protected "IN" outlet on the back panel of the UPS unit. Connect from "OUT" outlet to the equipment with another modem/fax/phone line cable.

Step 5: Disable and enable EPO function

This UPS is equipped with EPO function. By default, the UPS is delivered from factory with Pin 1 and pin 2 closed (a metal plate is connected to Pin 1 and Pin2) for UPS normal operation. To activate EPO function, remove two screws on EPO port and green connector will be removed.

Note: The EPO function logic can be set up via LCD setting. Please refer to program 16 in UPS setting for the details.

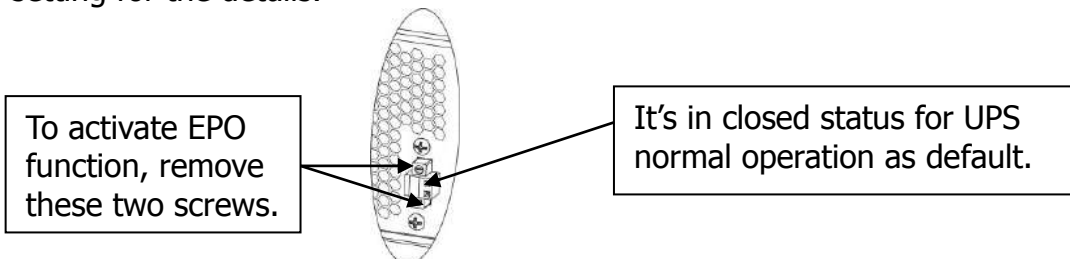

Step 6: External battery connection (for long-run models only)

Connect one end of external battery cable to UPS unit and the other end to battery box. See below chart for detailed connection.

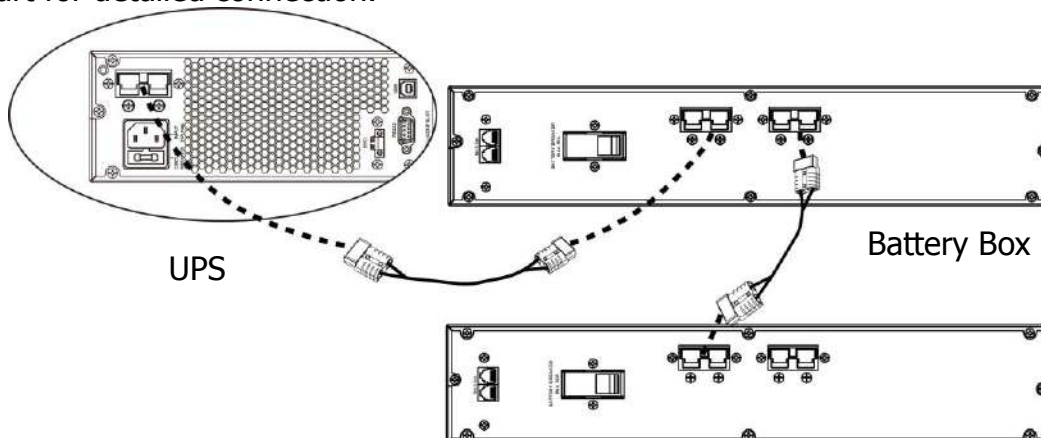

NOTE: Maximum connected external battery boxes up to 4 units.

Battery Box

Step 7: Turn on the UPS

Press the ON/Mute button on the front panel for two seconds to power on the UPS.

Note: The battery charges fully during the first five hours of normal operation. Do not expect full battery run capability during this initial charge period.

Step 8: Install software

For optimal computer system protection, install UPS monitoring software to fully configure UPS shutdown. Please follow steps below to download and install monitoring software:

1. Go to the website <http://www.power-software-download.com>
2. Click ViewPower software icon and then choose your required OS to download the software.
3. Follow the on-screen instructions to install the software.
4. When your computer restarts, the monitoring software will appear as an orange plug icon located in the system tray, near the clock.

2-4 Battery Replacement

NOTICE: This UPS is equipped with internal batteries and user can replace the batteries without shutting down the UPS or connected loads.(hot-swappable battery design)

Replacement is a safe procedure, isolated from electrical hazards.

CAUTION!! Consider all warnings, cautions, and notes before replacing batteries.

Note: Upon battery disconnection, equipment is not protected from power outages.

Step 1

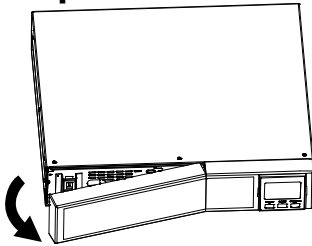

Remove front panel.

Step 2

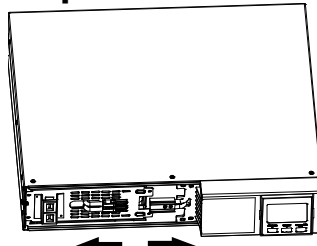

Disconnect battery wires.

Step 3

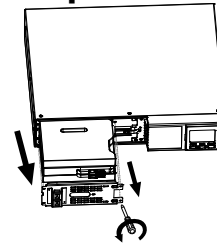

Pull out the battery box by removing two screws on the front panel.

Step 4

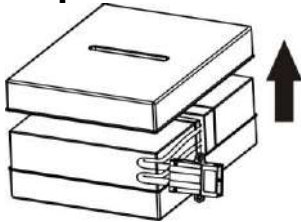

Remove the top cover of battery box and replace the inside batteries.

Step 5

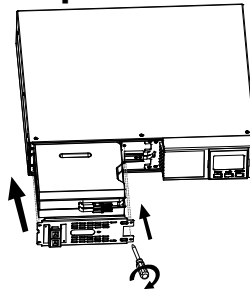

After replacing the batteries, put the battery box back to original location and screw it tightly.

Step 7

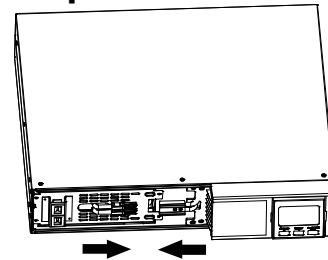

Re-connect the battery wires.

Step 8

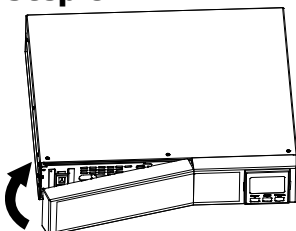

Put the front panel back to the unit.

2-5 Battery Kit Assembly (option)

NOTICE: Please assemble battery kit first before installing it inside of UPS. Please select correct battery kit procedure below to assemble it.

2-battery kit

Step 1: Remove adhesive tapes.

Tapes

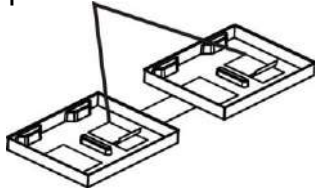

Step 3: Put assembled battery packs on one side of plastic shells and insert one more defect battery on the space.

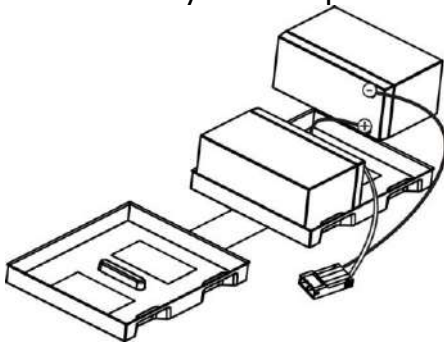

Step 2: Connect all battery terminals by following below chart.

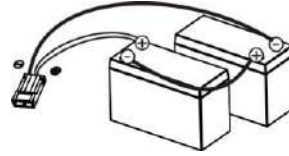

Step 4: Cover the other side of plastic shell as below chart. Then, battery kit is assembly well.

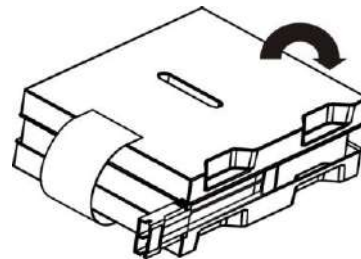

4-battery kit

Step 1: Remove adhesive tapes.

Tapes

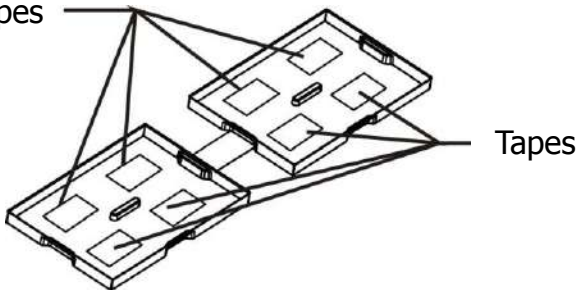

Step 3: Put assembled battery packs on one side of plastic shells.

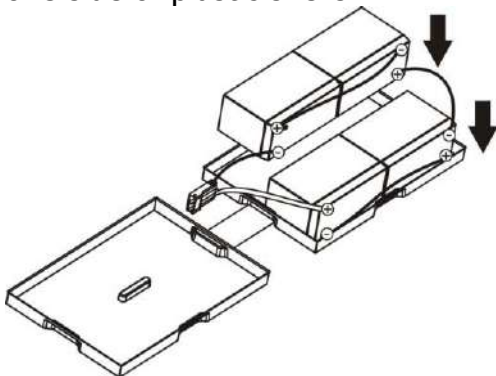

Step 2: Connect all battery terminals by following below chart.

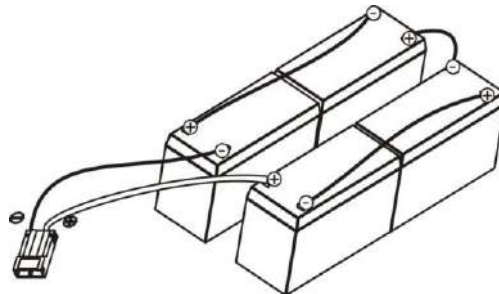

Step 4: Cover the other side of plastic shell as below chart. Then, battery kit is assembly well.

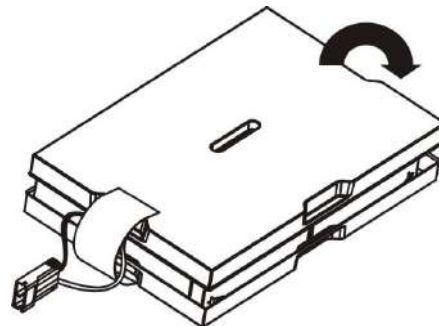

6-battery kit

Step 1: Remove adhesive tapes.

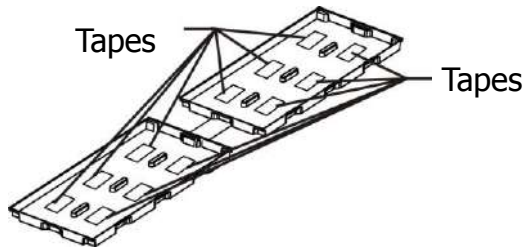

Step 2: Connect all battery terminals by following below chart.

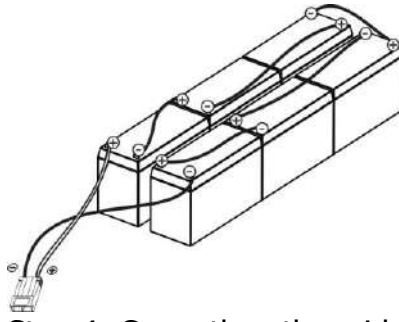

Step 3: Put assembled battery packs on one side of plastic shells.

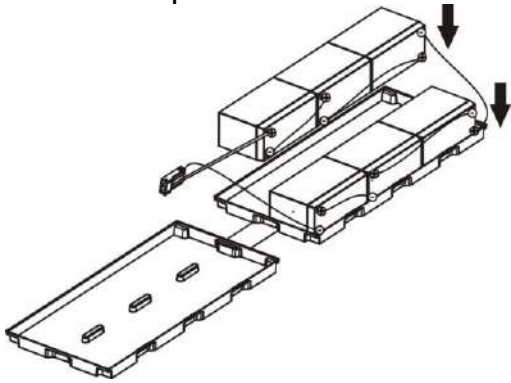

Step 4: Cover the other side of plastic shell as below chart. Then, battery kit is assembly well.

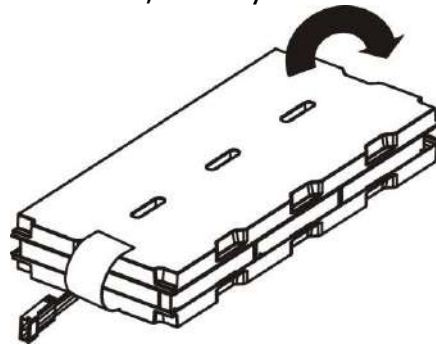

3. Operations



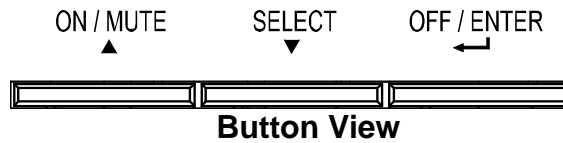





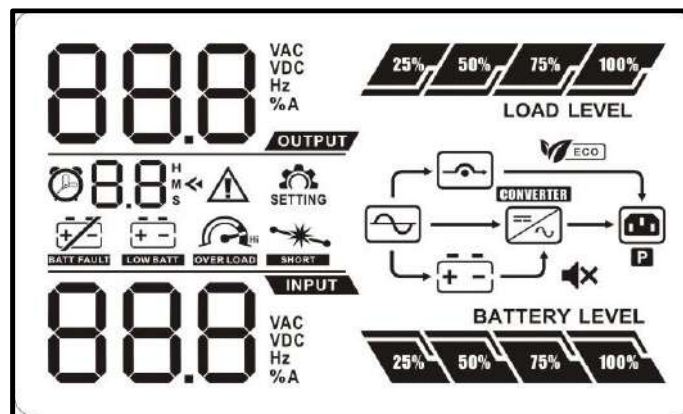





3-1. Button Operation



Button	Function
ON/MUTE Button	<ul style="list-style-type: none"> ➤ Turn on the UPS: Press and hold ON/Mute button for at least 2 seconds to turn on the UPS. ➤ Mute the alarm: After the UPS is turned on in battery mode, press and hold this button for at least 3 seconds to disable or enable the alarm system. But it's not applied to the situations when warnings or errors occur. ➤ Up key: Press this button to display previous selection in UPS setting mode. ➤ Switch to UPS self-test mode: Press and hold ON/Mute button for 3 seconds to enter UPS self-testing while in AC mode
OFF/ENTER Button	<ul style="list-style-type: none"> ➤ Turn off the UPS: Press and hold this button at least 2 seconds to turn off the UPS ➤ Confirm selection key: Press this button to confirm selection in UPS setting mode.
SELECT Button	<ul style="list-style-type: none"> ➤ Switch LCD message: Press this button to change the LCD message for input voltage, input frequency, battery voltage, output voltage and output frequency. ➤ Setting mode: Press and hold this button for 3 seconds to enter UPS setting mode when UPS is off. ➤ Down key: Press this button to display next selection in UPS setting mode.

3-2. LCD Panel

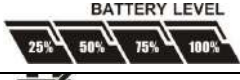

Display	Function
Backup time information	
 8.8 ^H _M _S	Indicates the estimated backup time. H: hours, M: minute
Configuration and fault information	
8.8 <	Indicates the configuration items, and the configuration items are listed in details in section 3-5.
8.8 < 	Indicates the warning and fault codes, and the codes are listed in details in section 3-7 and 3-8.
Output information	
88.8 ^{VAC} _{VDC} _{Hz} _{%A} OUTPUT	Indicates the output voltage and output frequency. V: voltage, Hz: frequency
Load information	
 LOAD LEVEL	Indicates the load level by 0-24%, 25-49%, 50-74%, and 75-100%.
 OVER LOAD	Indicates overload.
 SHORT	Indicates the load or the UPS output is short circuited.
Programmable outlets information	
	Indicates that programmable management outlets are working.
Mode operation information	
	Indicates the UPS connects to the mains.
	Indicates the battery is working.
	Indicates the bypass circuit is working.
	Indicates the ECO mode is enabled.
	Indicates the inverter circuit is working.
	Indicates the output is working.
	Indicates that the UPS alarm is disabled.
Battery information	
 BATTERY LEVEL	Indicates the Battery level by 0-24%, 25-49%, 50-74%, and 75-100%.
 BATT FAULT	Indicates the battery is fault.
 LOW BATT	Indicates low battery level and low battery voltage.
Input & Battery voltage information	
88.8 ^{INPUT} _{VAC} _{VDC} _{Hz} _{%A}	Indicates the input voltage, input frequency and battery voltage. Vac: Input voltage, Vdc: battery voltage, Hz: input frequency

3-3. Audible Alarm

Battery Mode	Sounding every 10 seconds
Low Battery	Sounding every 2 seconds
Overload	Sounding every second
Fault	Continuously sounding

3-4. LCD Display Wordings Index

Abbreviation	Display content	Meaning
ENA	ENR	Enable
DIS	dl S	Disable
ESC	ESC	Escape
CHA	CHR	Charger current
bo	bo	Boost
bu	bu	Buck
ON	ON	ON
OK	OK	OK
EPO	EPO	EPO
AO	AO	Active open
AC	AC	Active close
TP	TP	Temperature
CH	CH	Charger
EE	EE	EEPROM error
BR	BR	Battery Replacement

3-5. UPS Setting

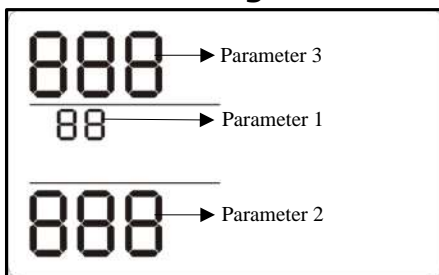

There are three parameters to set up the UPS.

Parameter 1: It's for program alternatives. Refer to below table.

Parameter 2 and parameter 3 are the setting options or values for each program

● 01: Output voltage setting

Interface	Setting
	<p>For 208/220/230/240 VAC models, you may choose the following output voltage:</p> <ul style="list-style-type: none"> 208: presents output voltage is 208Vac 220: presents output voltage is 220Vac 230: presents output voltage is 230Vac (Default) 240: presents output voltage is 240Vac <p>For 110/115/120/127 VAC models, you may choose the following output voltage:</p> <ul style="list-style-type: none"> 110: presents output voltage is 110Vac 115: presents output voltage is 115Vac 120: presents output voltage is 120Vac (Default) 127: presents output voltage is 127Vac

- 02: Programmable outlets enable/disable

Interface	Setting
	ENA: Programmable outlets enable (Default) DIS: Programmable outlets disable

- 03: Programmable outlets setting

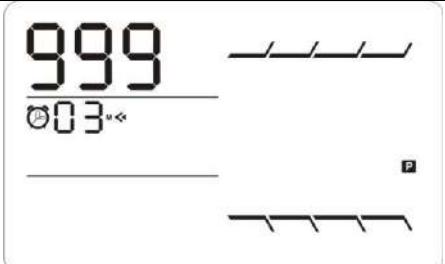
Interface	Setting
	Setting the backup time limits in minutes from 0-999 for programmable outlets which connect to non-critical devices on battery mode.

- 04: Maximum charger current setting

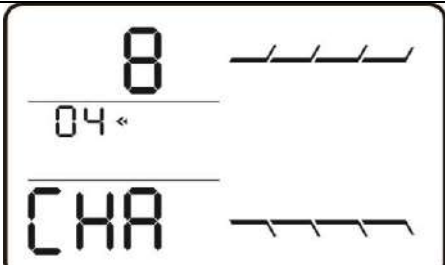
Interface	Setting
	Set up the maximum charger current. 1/2/4/6/8: setting the maximum charger current at 1/2/4/6/8 Ampere. (Default: 8A) Note: This setting is only effective for super charger.

- 06: Autonomy limitation setting

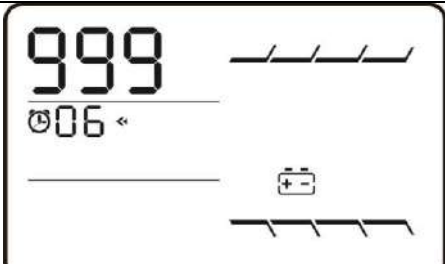
Interface	Setting
	Set up backup time on battery mode for general outlets. 0-999: setting the backup time in minutes from 0-999 for general outlets on battery mode. DIS: Disable the autonomy limitation and the backup time will depend on battery capacity. (Default) Note: When setting as "0", the backup time will be only 10 seconds.

- 07: Battery total AH setting

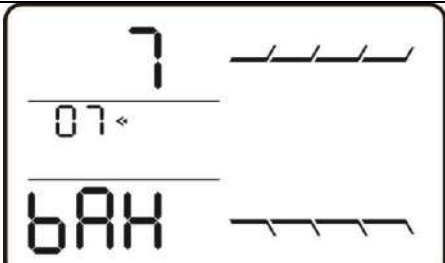
Interface	Setting
	Set up the battery total AH of the UPS. 7-999: setting the battery total capacity from 7-999 in AH. Please set the correct battery total capacity if external battery bank is connected.

- 08: EPO logic setting

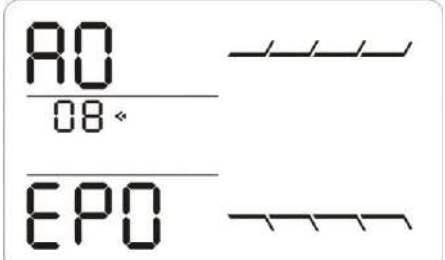
Interface	Setting
	<p>Set up the EPO function control logic.</p> <p>AO: Active Open (Default). When AO is selected as EPO logic, it will activate EPO function with Pin 1 and Pin 2 in open status.</p> <p>AC: Active Close. When AC is selected as EPO logic, it will activate EPO function with Pin 1 and Pin 2 in close status.</p>

- 00: Exit setting

Interface	Setting
	<p>Exit the setting mode.</p>

Steps for setting programmable outlet

Step 1:

Before entering setting mode, the UPS should be in Stand-by mode (off-charging) and make sure the battery is connected. The LCD display is shown as right.

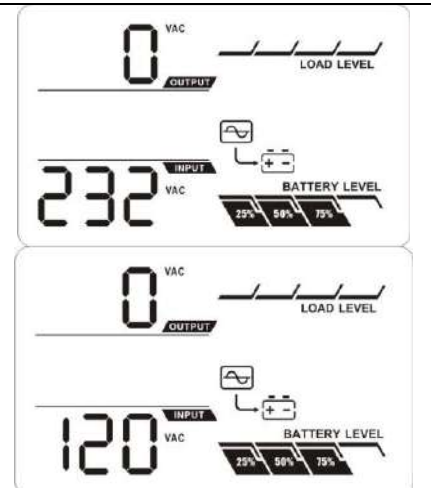

Step 2:

Press and hold the "Selection" button for 3 seconds to enter Setting mode.

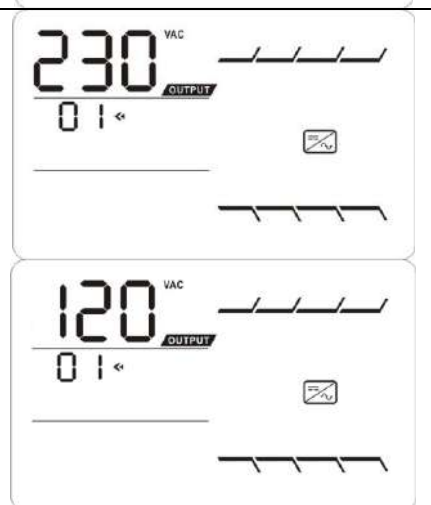

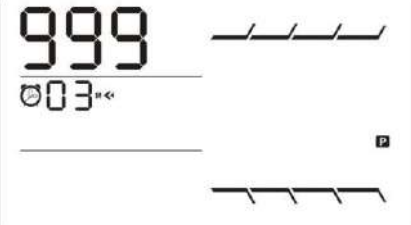
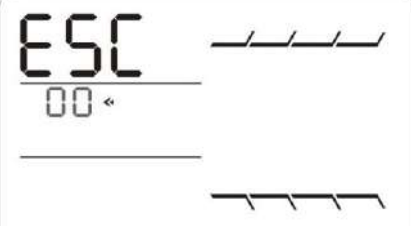
<p>Step 3: Press the "Up" button (ON/MUTE) to switch to "02" of program list. Then press "Enter" button to enter value setting of parameter 2. Press the "Up" button to change the value to "ENA" to enable the programmable outlet function. Then press "Enter" button again to confirm the setting.</p>	
<p>Step 4: Press the "Up" button (ON/MUTE) again to switch to "03" of program list. Then press "Enter" button for setting programmable outlet time. Push "Up" button to change the value of backup time according your demand. Then press "Enter" to confirm the setting.</p>	
<p>Step 5: Press "Up" button (ON/MUTE) to switch to "00" of program list. Then press "Enter" button to exit setting menu.</p>	
<p>Step 6: Disconnect AC input and wait until the LCD display is off. The new setting will be activated when turning on the UPS again.</p>	

3-6. Operating Mode Description

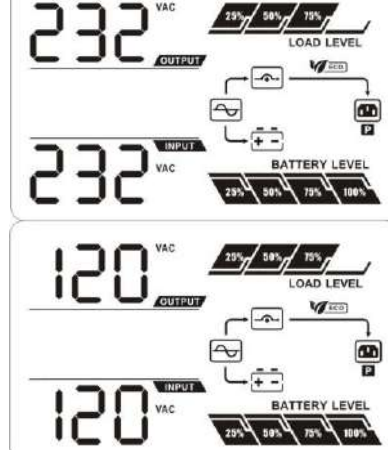
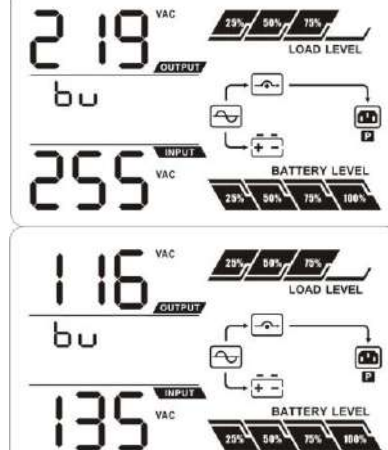















Operating mode	Description	LCD display
ECO mode	When the input voltage is within voltage regulated range, UPS will power the output directly from the mains. ECO is an abbreviation of Efficiency Corrective Optimizer. In this mode, when battery is fully charged, the fan will stop working for energy saving.	
Buck mode when AC is normal.	When the input voltage is higher than the voltage regulation range but lower than high loss point, the buck AVR will be activated.	

<p>Boost mode when AC is normal.</p>	<p>When the input voltage is lower than the voltage regulation range but higher than low loss point, the boost AVR will be activated.</p>	
<p>Battery mode</p>	<p>When the input voltage is beyond the acceptable range or power failure and alarm is sounding every 10 seconds, UPS will backup power from battery.</p>	
<p>Standby mode</p>	<p>UPS is powered off and no output supply power, but still can charge batteries.</p>	

3-7. Faults Reference Code











Fault event	Fault code	Icon	Fault event	Fault code	Icon
Bus start fail	01	x	Inverter output short	14	
Bus over	02	x	Battery voltage too high	27	
Bus under	03	x	Battery voltage too low	28	
Inverter soft start fail	11	x	Over temperature	41	X
Inverter voltage high	12	x	Over load	43	
Inverter voltage Low	13	x	Charger failure	45	X

3-8. Warning Indicator

Warning	Icon (flashing)	Alarm
Low Battery	 	Sounding every 2 seconds
Overload	 	Sounding every second
Battery is not connected	 	Sounding every 2 seconds
Over Charge	 	Sounding every 2 seconds
Site wiring fault	 	Sounding every 2 seconds
EPO enable	 EP	Sounding every 2 seconds
Over temperature	 TP	Sounding every 2 seconds
Charger failure	 CH	Sounding every 2 seconds
Battery fault	 	Sounding every 2 seconds (At this time, UPS is off to remind users of something wrong with battery)
EEPROM error	 EE	Sounding every 2 seconds
Battery replacement	 BT	Sounding every 2 seconds

4. Troubleshooting

If the UPS system does not operate correctly, please solve the problem by using the table below.

Symptom	Possible cause	Remedy
No indication and alarm even though the mains is normal.	The AC input power is not connected well.	Check if input power cord firmly connected to the mains.
	The AC input is connected to the UPS output.	Plug AC input power cord to AC input correctly.
The icon  and the warning code EP flashing on LCD display and alarm is sounding every 2 seconds.	EPO function is activated.	Set the circuit in close position to disable EPO function.
The icon  and  flashing on LCD display and alarm is sounding every 2 seconds.	Line and neutral conductors of UPS input are reversed.	Rotate mains power socket by 180° and then connect to UPS system.
The icon  and  flashing on LCD display and alarm is sounding every 2 seconds.	The external or internal battery is incorrectly connected.	Check if all batteries are connected well.
Fault code is shown as 27 and the icon  is lighting on LCD display and alarm is continuously sounding.	Battery voltage is too high or the charger is fault.	Contact your dealer.
Fault code is shown as 28 and the icon  is lighting on LCD display and alarm is continuously sounding.	Battery voltage is too low or the charger is fault.	Contact your dealer.
The icon  and the icon  are flashing on LCD display and alarm is sounding every second.	UPS is overload	Remove excess loads from UPS output.
Fault code is shown as 43 and The icon  is lighting on LCD display and alarm is continuously sounding.	The UPS shut down automatically because of overload at the UPS output.	Remove excess loads from UPS output and restart it.
Fault code is shown as 14 and alarm is continuously sounding.	The UPS shut down automatically because short circuit occurs on the UPS output.	Check output wiring and if connected devices are in short circuit status.

Symptom	Possible cause	Remedy
Fault code is shown as 01, 02, 03, 11, 12, 13 and 41 on LCD display and alarm is continuously sounding.	A UPS internal fault has occurred.	Contact your dealer
Battery backup time is shorter than nominal value	Batteries are not fully charged	Charge the batteries for at least 5 hours and then check capacity. If the problem still persists, consult your dealer.
	Batteries defect	Contact your dealer to replace the battery.
Fault code is shown as 45 on LCD display. At the same time, alarm is continuously sounding.	The charger does not have output and battery voltage is less than 10V/PC.	Contact your dealer.

5. Storage and Maintenance

Operation

The UPS system contains no user-serviceable parts. If the battery service life (3~5 years at 25°C ambient temperature) has been exceeded, the batteries must be replaced. In this case, please contact your dealer.



Be sure to deliver the spent battery to a recycling facility or ship it to your dealer in the replacement battery packing material.

Storage

Before storing, charge the UPS 5 hours. Store the UPS covered and upright in a cool, dry location. During storage, recharge the battery in accordance with the following table:

Storage Temperature	Recharge Frequency	Charging Duration
-25°C - 40°C	Every 3 months	1-2 hours
40°C - 45°C	Every 2 months	1-2 hours

6. Specifications

MODEL	800	1.1K(L)	1.5K	2K(L)	2.5K	3K(L)	
CAPACITY	800 VA / 720 W	1100 VA / 990 W	1500 VA / 1350 W	2000 VA / 1800 W	2500 VA / 2250 W	3000 VA / 2700 W	
INPUT							
Acceptable Voltage Range	81-145 VAC or 162-290 VAC						
Frequency Range	60/50 Hz (auto sensing)						
OUTPUT							
Voltage Regulation (AC Mode)	110/115/120/127 VAC or 208/220/230/240 VAC						
Voltage Regulation (Batt. Mode)	±1.5%(before battery alarm)						
Frequency Range (Batt. Mode)	50 Hz or 60 Hz ± 1 Hz						
Current Crest Ratio	3:1						
Harmonic Distortion	2% max @ 100% linear load, 5% max @ 100% non-linear load (before low battery alarm)						
Transfer Time	Typical 2-6 ms, 10ms max.						
Waveform (Batt. Mode)	Pure Sine Wave						
EFFICIENCY							
AC Mode	95% for 110/115/120/127 VAC ; 97% for 208/220/230/240 VAC						
Buck & Boost Mode	93% for 110/115/120/127 VAC ; 95% for 208/220/230/240 VAC						
Battery Mode	88% for 110/115/120/127 VAC 89% for 208/220/230/240 VAC	90% for 110/115/120/127 VAC 91% for 208/220/230/240 VAC	90% for 110/115/120/127 VAC 91% for 208/220/230/240 VAC	90% for 110/115/120/127 VAC 92% for 208/220/230/240 VAC	90% for 110/115/120/127 VAC 92% for 208/220/230/240 VAC	90% for 110/115/120/127 VAC 92% for 208/220/230/240 VAC	
BATTERY							
Standard Model	Battery Type & Number	12 V/7 Ahx2	12 V/9 Ahx2	12 V/7 Ahx4	12 V/9 Ahx4	12 V/7 Ahx6	12 V/9 Ahx6
	Charging Voltage	27.4 VDC ± 1%		54.8 VDC ± 1%		82.1 VDC ± 1%	
	Recharge Time	4 hours recover to 90% capacity					
Long-run Model	Charging Current	N/A	1A/2A/4A/8A	N/A	1A/2A/4A/8A	N/A	1A/2A/4A/8A
	Charging Voltage	N/A	27.4 VDC±1%	N/A	54.8 VDC±1%	N/A	82.1 VDC ±1%
PROTECTION							
Full Protection	Overload, short, discharge, and overcharge protection						
ALARM							
Battery Mode	Sounding every 10 seconds						
Low Battery	Sounding every 2 seconds						
Overload	Sounding every second						
Battery Replacement Alarm	Sounding every 2 seconds						
Fault	Continuously sounding						
PHYSICAL							
Standard Model	Dimension, DXWXH (mm)	410 x 438 x 88		510 x 438 x 88		630 x 438 x 88	
	Net Weight (kg)	12.9	13.4	19.5	21.5	27.7	29.3
Long-run Model	Dimension, DXWXH (mm)	N/A	410 x 438 x 88	N/A	410 x 438 x 88	N/A	110/115/120/127 VAC: 510 x 438 x 88 208/220/230/240 VAC: 410 x 438 x 88
	Net Weight (kg)	N/A	9	N/A	11	N/A	110/115/120/127 VAC: 13.9 208/220/230/240 VAC: 11.9
ENVIRONMENT							
Operating Humidity	0-90 % RH @ 0- 40°C (non-condensing)						
Noise Level	Less than 45dB						
MANAGEMENT							
Smart RS-232/USB	Supports Windows® 2000/2003/XP/Vista/2008, 7/8, Linux, Unix, and MAC						
Optional SNMP	Power management from SNMP manager and web browser						

* Derate capacity to 80% of capacity when the output voltage is adjusted to 208VAC.

**Product specifications are subject to change without further notice.